

2025



PRODUCT CATALOGUE

INSTALLATION - PLUMBING - HVAC

SAFE SECURE SOLID



SAFE SECURE SOLID

INTRODUCTION

Welcome to the 2025 Rofix catalogue! A new step in the 47 year history of our well-known brand of fasteners and fixings for the plumbing and HVAC market. 2025 will be the year that Rofix will return to the ISH Fair in Frankfurt. We strongly believe in a personal approach with the market, with you! Rofix keeps on developing further to be future-proof. Obtaining the ISO 9001 certificate allows us to expand our horizon and to grow. In these challenging times, the market needs more than ever a **SAFE, SECURE** and **SOLID** partner. We are that partner.

Our expanded machine park meets today's needs and offers us the flexibility that today's market requires. This offers us the advantage to link innovation to production.

With our Belgian heritage and headquarters and the Polish craftsmanship we combine 2 worlds for a sustainable solution for your needs. Reach out, we are happy to prove our 47 years of experience to meet your demands!



RON VAESSEN
2nd generation
Rofix Group



INSTALLATION - PLUMBING - HVAC

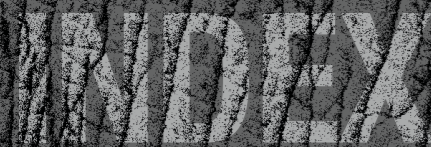

DISCOVER THE LATEST IN INSTALLATION, SANITARY, AND HVAC SOLUTIONS. OUR COMPREHENSIVE RANGE OF PRODUCTS IS DESIGNED TO MEET THE HIGHEST STANDARDS OF QUALITY, EFFICIENCY, AND RELIABILITY. WHETHER YOU'RE LOOKING FOR ADVANCED HVAC SYSTEMS, TOP-NOTCH SANITARY FITTINGS, OR RELIABLE INSTALLATION EQUIPMENT, YOU'LL FIND EVERYTHING YOU NEED TO ENSURE YOUR PROJECTS ARE COMPLETED TO PERFECTION. EXPLORE OUR OFFERINGS AND EXPERIENCE THE INNOVATION AND EXCELLENCE THAT SET US APART.

01.

PLUMBING FASTENERS



Standard clamp	8
Double classic clamp	8
Classic clamp	9
Turbo clamp	10
Double insulated clamp	10
Double insulated clamp with screw	11
Double insulated clamp in copper with screw	11
Delta clamp	12
Drain clamp	12
Ventilation clamp with pe-insulation	13
Ventilation clamp with rubber	13
Gasboiler evacuation clamp	14
Quick-Fix	14
Drive-in nylon clip	15
Clamp accessories	15
Single ACO clamp	15
Double ACO clamp	16
Single ACO clamp insulated	16
Double ACO clamp insulated	17
Dowel screw	17
Distance rose	17
Single metal floor clamp	18
Double metal floor clamp	18

02.

RAIL AND ACCESSORIES



Mountingrail R27-18	20
Cantilever arm R27-18	20
Mountingrail R30-15	20
Cantilever arm R30-15	20
Mountingrail R30-30	21
Cantilever arm R30-30	21
Mountingrail R35-20	21
Cantilever arm R35-20	21
Mountingrail R41-21	22
Cantilever arm R41-21	22
Mountingrail R41-41	22
Cantilever arm R41-41	22
Rofix heavy duty cantilever arm R30-30	23
U-connection mountingrail cantilever arm	23

Vertical cantilever arm R41-21	23
Connection mountingrail cantilever arm	23
Wallfixation mountingrail	24
Strut beam clamp	24
Beam clamp	24
Slide nut	24
Slide nut for rail & cantilever arm 41x41	25
Hexagonal nut	25
Washer	25
Long nut	25
Threaded rod 4.8	26
Hammerhead bolt for R 30x15, 30x20, 30x30	26
Hammerhead bolt for 41x21 AND 41x41	26
Trapezoidal hanger	26

03. MOUNTING ACCESSORIES



Perfoband galva 12mm	28
Perfoband galva 17mm	28
Perfoband galva 25mm	29
Perfoband plastified grey 14mm	30
Perfoband plastified grey 27mm	30
Perfoband plastified grey 19mm	31
Fixpin drive nail	32
Metric eye bolt	32
Fixpin tool	32
Flat eye screw	32
Nylon plug	33
Brass plug	33
Nylon plug with collar	33
Universal fastening set	33
Speedplug	34
Toilet fastening set	34
Nail-plug flat headed	34
Sink fastening set	34
Pump support with bridge	35
Universal pump support with fastening set	35
Pump support without bridge	35
Angle bracket set for sink ral 9016	35
Coverfix floor	36
Coverfix wall	36
Coverfix curve	36
Coverfix wall clamp	36
Double thread screw	37

Expansion vessel bracket	37
Single collectorbracket	38
Double collectorbracket	38
Collectorbracket foot	38

04. UNIT MOUNTINGS



Unit floor stand	40
Unit wall Support with backrail	40
Unit wall support triangle	40

05. WALL BRACKETS



U2	42
Trias S40-50-60	42
Trias S50-60-70	43
Trias Vario S40-50-60	43
Trias hygienic	44
Trias hygienic white	44
8-P SuperSafe	45
Alu radiator bracket	45
Fix-Matic	46
L-Bracket	46
L-Bracket VDI class 3	47
Screw-on set	47
Angle bracket set type 2003	48
Angle bracket set type 100	48

06. FLOOR BRACKETS



Expander	50
unistand finished floor	51
Unistand unfinished floor	51
Unifix	52
Duo floor bracket with fastening set	52
Duo floor bracket with inner mountingset Type II	53
Duo floor bracket H1.200mm with universal fixation set	53
Duo standpipe set	54
Accessories floor brackets	54

PLUMBING FASTENERS: BUILT FOR DURABILITY, PRECISION, AND PERFORMANCE

01. PLUMBING FASTENERS



STANDARD CLAMP

WHY

- Quick-close system on all diameters
- Suitable for horizontal or vertical fixing/mounting (wall, ceiling and/or mounting rail)



DOUBLE CLASSIC CLAMP

WHY

- Lock washer
- Suitable for horizontal or vertical fixing/mounting (wall, ceiling and/or mounting rail)

SPECIFICATIONS

- Heat resistance following DIN 4102: Class B2
- Temperature resistance: from -50°C to +110°C
- Sound-absorbing rubber (EPDM) according to DIN 4109

Article no.	∅(mm)	∅(")	ØM	📦
50004764	15-17	3/8"	M8	100 pc
50004765	18-23	1/2"	M8	100 pc
50004766	26-31	3/4"	M8	100 pc
50004767	32-35	1"	M8	50 pc
50004768	38-43	5/4"	M8	50 pc
50004769	44-46		M8	50 pc
50004770	47-51	6/4"	M8	50 pc
50004771	50-56		M8/M10	50 pc
50004772	57-61	2"	M8/M10	50 pc
50004773	63-67		M8/M10	25 pc
50004774	70-73		M8/M10	25 pc
50004776	74-80	2 1/2"	M8/M10	25 pc
50004778	83/91	3"	M8/M10	25 pc
50004779	101-106		M8/M10	25 pc
50004780	108-114	4"	M8/M10	25 pc
50004781	118-125		M8/M10	25 pc
50004783	136-139	5"	M10	15 pc
50004784	159-163		M10	15 pc
50004785	165-169	6"	M10	15 pc

Article no.	∅(mm)	∅(")	ØM	📦
50004706	15-18	3/8"	M8/M10	100 pc
50004707	20-23	1/2"	M8/M10	75 pc
50004708	25-28	3/4"	M8/M10	50 pc
50004709	32-35	1"	M8/M10	50 pc



CLASSIC CLAMP

WHY

- Robust pipe bracket with 2 screws for all types of tubes
- Suitable for horizontal or vertical fixing/mounting (wall, ceiling and/or mounting rail)
- Quick-close system

SPECIFICATIONS

- Heat resistance following DIN 4102: Class B2
- Temperature resistance: from -50°C to +110°C
- Sound-absorbing rubber (EPDM) according to DIN 4109

Article no.	∅(mm)	∅(")	ØM	Box
50004710	12-14	1/4"	M8	150 pc
50004711	15-19	3/8"	M8	150 pc
50004712	20-23	1/2"	M8	100 pc
50004713	24-28	3/4"	M8	100 pc
50004714	31-35	1"	M8	50 pc
50004715	38-43	5/4"	M8	50 pc
50004716	44-49	6/4"	M8	50 pc
50001708	12-14	1/4"	M8/M10	150 pc
50004718	15-19	3/8"	M8/M10	150 pc
50004719	20-23	1/2"	M8/M10	100 pc
50004720	24-28	3/4"	M8/M10	100 pc
50004721	31-35	1"	M8/M10	50 pc
50004722	38-43	5/4"	M8/M10	50 pc
50004723	44-49	6/4"	M8/M10	50 pc
50004724	50-56		M8/M10	50 pc
50004725	57-61	2"	M8/M10	50 pc

Article no.	∅(mm)	∅(")	ØM	Box
50004726	63-67		M8/M10	50 pc
50004727	70-73		M8/M10	50 pc
50004728	74-80	2 1/2"	M8/M10	50 pc
50004729	83-91	3"	M8/M10	50 pc
50004730	101-106		M8/M10	25 pc
50004731	108-114	4"	M8/M10	25 pc
50004732	125		M8/M10	25 pc
50001724	131-135		M10	25 pc
50001725	136-139	5"	M10	15 pc
50004735	140-144		M10	15 pc
50004736	159-163		M10	15 pc
50001728	165-169	6"	M10	15 pc
50004738	193-200		M10	15 pc
50001730	210-212		M10	10 pc
50001731	216-220		M10	10 pc
50004741	250		M10	10 pc



TURBO CLAMP

WHY

- Extremely fast assembly thanks to click-hinge system
- Suitable for horizontal or vertical fixing/mounting (wall, ceiling and/or mounting rail)

SPECIFICATIONS

- Heat resistance following DIN 4102: Class B2
- Temperature resistance: from -50°C to +110°C
- Sound-absorbing rubber (EPDM) according to DIN 4109

Article no.	∅(mm)	∅(")	ØM	Box
50004745	12-14	1/4"	M8	150 pc
50004746	15-19	3/8"	M8	150 pc
50004747	20-23	1/2"	M8	100 pc
50004748	26-28	3/4"	M8	100 pc
50004749	32-35	1"	M8	50 pc
50004750	40-46	5/4"	M8	50 pc
50004751	48-53	6/4"	M8	50 pc
50004752	54-58		M8	50 pc
50004753	59-62		M8	50 pc
50005891	75-80	2 1/2"	M8	50 pc
50005890	83-91	3"	M8	50 pc
50004755	15-19	3/8"	M8/M10	150 pc
50004756	20-23	1/2"	M8/M10	100 pc
50004757	26-28	3/4"	M8/M10	100 pc
50004758	32-35	1"	M8/M10	50 pc
50004759	40-46	5/4"	M8/M10	50 pc
50004760	48-53	6/4"	M8/M10	50 pc
50004761	54-58		M8/M10	50 pc
50004762	59-62		M8/M10	50 pc



DOUBLE INSULATED CLAMP

WHY

- For mounting galvanized pipes

SPECIFICATIONS

- With PE-insulation (thickness 2mm)

Article no.	∅(mm)	∅(")	CD (mm)	Box
40000149	15		42	50 pc
40000158	15		60	50 pc
40000153	18	3/8"	42	50 pc
40000159	18	3/8"	60	50 pc
40000150	22	1/2"	52	50 pc
40000160	22	1/2"	60	50 pc
40000152	28	3/4"	60	50 pc
40000154	35	1"	65	50 pc
40000155	45	5/4"	75	50 pc
40000156	51	6/4"	80	50 pc
40000157	57	8/4"	90	50 pc



DOUBLE INSULATED CLAMP WITH SCREW

WHY

- For mounting galvanized pipes

SPECIFICATIONS

- With PE-insulation (thickness 2mm)
- Equipped with double thread screw (L=100mm or L=120mm)

Article no.	Ø (mm)	Ø (")	L (mm)	CD (mm)	📦
40000751	15		100	42	50 pc
40000756	15		100	60	50 pc
40000752	18	3/8"	100	42	50 pc
40000753	22	1/2"	100	52	50 pc
40000757	22	1/2"	100	60	50 pc
40000755	28	3/4"	100	60	50 pc
40000754	35	1"	100	65	50 pc
40002076	45	5/4"	100	75	50 pc
40002170	51	6/4"	100	80	50 pc
40000166	15		120	42	50 pc
40000748	15		120	60	50 pc
40000167	18	3/8"	120	42	50 pc
40000749	18	3/8"	120	60	50 pc
40000744	22	1/2"	120	52	50 pc
40000750	22	1/2"	120	60	50 pc
40000745	28	3/4"	120	60	50 pc
40000746	35	1"	120	65	50 pc
40000746	35	1"	120	65	50 pc



DOUBLE INSULATED CLAMP IN COPPER WITH SCREW

WHY

- For mounting copper pipes

SPECIFICATIONS

- With PE-insulation (thickness 2mm)
- Equipped with double thread screw (L=120mm)

Article no.	Ø (mm)	Ø (")	CD (mm)	📦
40000761	15		42	50 pc
40000762	18	3/8"	42	50 pc
40000763	22	1/2"	52	50 pc
40000764	28	3/4"	60	50 pc



DELTA CLAMP

WHY

- Suitable for mounting plastic (drain) pipes
- Suitable for horizontal or vertical fixing/mounting (wall, ceiling and/or mounting rail)
- Quick-close system with anti-lift guard
- Special profiling to prevent damage to the (drain) pipe

Article no.	Ø (mm)	Ø (")	Ø M	📦
50004787	20x2.20	32	M8/M10	100 pc
50004788	20x2.20	40	M8/M10	100 pc
50004789	20x2.20	50	M8/M10	100 pc
50005501	20x2.20	56	M8/M10	100 pc
50004790	20x2.20	63	M8/M10	100 pc
50004791	20x2.20	75	M8/M10	50 pc
50004792	20x2.20	80	M8/M10	50 pc
50004793	20x2.20	90	M8/M10	50 pc
50004794	20x2.20	100	M8/M10	50 pc
50004795	25x2.50	110	M8/M10	50 pc
50004796	25x2.50	125	M8/M10	25 pc
50004798	25x2.50	160	M8/M10	25 pc
50004800	25x2.50	200	M8/M10	25 pc
50005446	25x2.50	250	M8/M10	25 pc
50005447	25x2.50	315	M8/M10	5 pc
50004800	25x2.50	200	M8/M10	25 pc
40001317	25x2.50	225	M8	25 pc
50005446	25x2.50	250	M8/M10	10 pc
50005447	25x2.50	315	M8/M10	5 pc



DRAIN CLAMP

WHY

- Specially developed for vertical mounting
- Developed for drain pipes

Article no.	Ø (mm)	Ø M	📦
50000761	42	M8	25 pc
50000762	50	M8	25 pc
50000763	63	M8	25 pc
50000765	75	M8	25 pc
50000766	80	M8	25 pc
50000767	90	M8	25 pc
50000768	100	M8	25 pc
50000769	110	M8	25 pc
50000771	120	M8	25 pc
50000772	125	M8	25 pc
50000839	130	M8	25 pc
50000773	140	M8	25 pc
50000781	150	M8	25 pc
50000775	153	M8	25 pc
50000776	160	M8	25 pc
50000777	180	M8	25 pc
50000778	200	M8	25 pc



VENTILATION CLAMP WITH PE-INSULATION

WHY

- Perfect combination of aesthetic bracket WITH invisible insulation
- Equipped with anti-loss covers
- Easy to use: pipes can slide in the pipe clamp during processing
- The pipe clamp is pre-assembled and immediately

Article no.	∅(mm)	M	pc
50001913	80-84	M8	50 pc
50001915	100-105	M8	100 pc
50001916	125	M8	50 pc
40001460	150-155	M8	100 pc
50001917	160-165	M8	50 pc
40001461	180-185	M8	50 pc
50001918	200-205	M8	50 pc
40001462	224-229	M8	100 pc
50001919	250-255	M8	25 pc
40001464	280-285	M8	50 pc
50001920	315-322	M8	25 pc
50001921	355-362	M8	25 pc
50001059	400-407	M8	25 pc
50001060	450-457	M8	25 pc
50001061	500-507	M8	25 pc
50001062	560-567	M8	10 pc
50001064	630-639	M8	5 pc
50001065	710-719	M8	10 pc
50001066	800-810	M8	5 pc



VENTILATION CLAMP WITH RUBBER

WHY

- Quick-close system with anti-lift guard
- The pipe clamp is pre-assembled and immediately ready for use

Article no.	∅(mm)	M	pc
50004821	80-84	M8/M10	60 pc
50004822	100-105	M8/M10	60 pc
50004823	125	M8/M10	60 pc
50004825	150-155	M8/M10	60 pc
50004826	160-165	M8/M10	60 pc
50004827	180-185	M8/M10	60 pc
50004828	200-205	M8/M10	40 pc
50004830	250-255	M8/M10	40 pc
50004833	315-322	M8/M10	30 pc
50004834	355-362	M8/M10	30 pc
40003611	400-407	M8/M10	20 pc
40003612	450-457	M8/M10	20 pc
40003613	500-507	M8/M10	20 pc
40003614	560-567	M8/M10	10 pc
40003615	630-639	M8/M10	5 pc
40003616	710-719	M8/M10	10 pc
40003617	800-810	M8/M10	10 pc
40003618	900-910	M8/M10	10 pc
40003619	1.000-1.012	M8/M10	10 pc
40003620	1.120-1.132	M8/M10	20 pc
40003621	1.250-1.260	M8/M10	20 pc



GASBOILER EVACUATION CLAMP

WHY

- Specifically for vertical mounting
- Incl. bolts and plugs (L=100mm)

SPECIFICATIONS

- RAL 9016 lacquered

Article no.	∅(mm)	M	pc
40003493	100	M8	10 pc
40003494	125	M8	10 pc



QUICK-FIX

WHY

- Made of weather-resistant polyamide 6
- Multi-purpose in both plumbing/HVAC and electrical sectors for lightweight pipes
- High resistance to chemicals or gasoline
- Temperature resistance from -40°C to +90°C

Article no.	∅(mm)	pc
50001288	10-12	100 pc
50001289	14-16	100 pc
50001290	16,5-20	100 pc
50001291	20-23	50 pc
50001292	25-29	50 pc
50001293	32-35	50 pc
50001294	40-45	25 pc
50001295	48-55	25 pc
50001296	58,5-65	25 pc

* Can be combined with "Rivet M6x50 flat head" (Ref. 50001819)

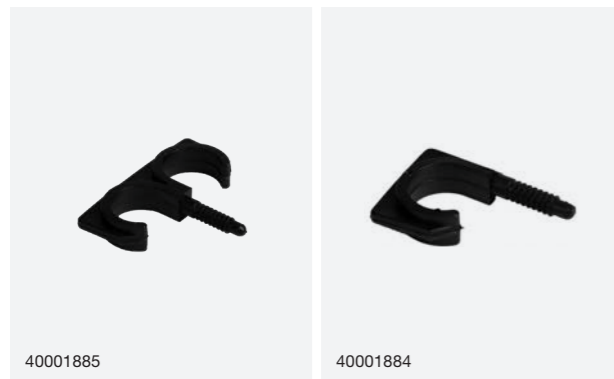

DRIVE-IN NYLON CLIP

WHY

- Easy to use
- For floor applications
- Multi-purpose in both plumbing/HVAC and electrical sectors for lightweight pipes

Article no.	Description	Ø (mm)		
40001884	Single clip	22-26	100 pc	1.000 pc
40001885	Double clip	22-26	100 pc	1.000 pc



SINGLE ACO CLAMP

WHY

- For the mounting of copper and PVC pipes
- For horizontal or vertical mounting against the wall or ceiling
- Lightweight clamp for light pipes



DOUBLE ACO CLAMP

WHY

- For the mounting of copper and PVC pipes
- For horizontal or vertical mounting against the wall or ceiling
- Lightweight clamp for light pipes



SINGLE ACO CLAMP INSULATED

WHY

- For the mounting of copper and PVC pipes
- For horizontal or vertical mounting against the wall or ceiling
- Lightweight clamp for light pipes

SPECIFICATIONS

- Heat resistance according DIN 4102: Class B2
- Temperature resistance: from -50°C to +110°C
- Sound-absorbing rubber (EPDM) according to DIN 4109



CLAMP ACCESSORIES

Article no.	Description	
40000162	Bolt and nut double pipe clamp	50 pc
40000163	Mounting bolt M8x90	100 pc
40000164	Mounting bolt M8x120	100 pc
40000165	Cap nut M8	100 pc

Article no.	Ø (mm)	Ø M		
50000840	10	M7x100	100 pc	1.000 pc
50000841	12	M7x100	100 pc	1.000 pc
50000842	15	M7x100	100 pc	1.000 pc
50000843	18	M7x100	100 pc	1.000 pc
50000850	22	M7x100	100 pc	1.000 pc
50001142	28	M7x100	100 pc	1.000 pc
50000852	32	M7x100	100 pc	500 pc
50000529	34	M7x100	50 pc	500 pc
50000853	40	M7x100	50 pc	500 pc
50000854	50	M7x100	25 pc	500 pc

Article no.	Ø (mm)	Ø M		
50000536	10	M7x100	100 pc	1.000 pc
50000858	12	M7x100	100 pc	1.000 pc
50000537	16	M7x100	100 pc	1.000 pc
50000860	18	M7x100	100 pc	500 pc
50000861	22	M7x100	50 pc	500 pc
50000538	28	M7x100	25 pc	250 pc

Article no.	Ø (mm)	Ø M		
50000530	10	M7x100	100 pc	1.000 pc
50000855	12	M7x100	100 pc	1.000 pc
50000531	16	M7x100	100 pc	1.000 pc
50000856	18	M7x100	100 pc	1.000 pc
50000857	22	M7x100	100 pc	1.000 pc
50000532	28	M7x100	50 pc	500 pc
50000533	32	M7x100	50 pc	500 pc
50000534	34	M7x100	50 pc	500 pc
50000535	40	M7x100	50 pc	500 pc



DOUBLE ACO CLAMP INSULATED

WHY

- For the mounting of copper and PVC pipes
- For horizontal or vertical mounting against the wall or ceiling
- Lightweight clamp for light pipes

SPECIFICATIONS

- Heat resistance according DIN 4102: Class B2
- Temperature resistance: from -50°C to +110°C
- Sound-absorbing rubber (EPDM) according to DIN 4109

Article no.	Ø (mm)	M	pc	pc
50000540	10	M7x100	100 pc	1.000 pc
50000541	12	M7x100	100 pc	1.000 pc
50000542	14	M7x100	100 pc	1.000 pc
50000862	16	M7x100	50 pc	1.000 pc
50000863	18	M7x100	50 pc	500 pc
50000864	22	M7x100	50 pc	500 pc
50000543	28	M7x100	25 pc	250 pc



DOWEL SCREW

Article no.	L (mm)	M	pc	pc
50000930	30	M7x100	100 pc	1.000 pc
50000865	40	M7x100	100 pc	1.000 pc
50000544	50	M7x100	100 pc	1.000 pc
50000866	60	M7x100	100 pc	1.000 pc
50000545	70	M7x100	100 pc	1.000 pc
50000867	80	M7x100	100 pc	1.000 pc



DISTANCE ROSE

Article no.	H (mm)	M	pc	pc
50000470	9	25	100 pc	1.000 pc
50000471	14	29	100 pc	1.000 pc
50000472	19	33	100 pc	1.000 pc
50000473	24	42	100 pc	1.000 pc
50000474	29	39	100 pc	1.000 pc



SINGLE METAL FLOOR CLAMP

WHY

- For fixing pipes on the floor
- Perfect in combination with a nail gun

Article no.	Ø (mm)	pc
50000642	16	250 pc
50000643	18	200 pc
50000644	20	200 pc
50000645	22	175 pc
50000646	24	150 pc
50000647	28	125 pc
50000648	35	100 pc
50000649	40	100 pc



DOUBLE METAL FLOOR CLAMP

WHY

- For fixing pipes on the floor
- Perfect in combination with a nail gun

Article no.	Ø (mm)	pc
50000634	16	150 pc
50000635	18	100 pc
50000636	20	100 pc
50000637	22	100 pc
50000638	24	100 pc
50000639	28	50 pc
50000640	35	50 pc
50000641	40	50 pc

RAIL AND
ACCESSORIES
DELIVERING
SAFETY AND
STRENGTH

02. RAIL AND ACCESSORIES



MOUNTINGRAIL R27-18

WHY

- Efficient and quick fixing of one or more pipes
- Excellent for use as support when attaching air ducts
- Unlimited application possibilities for wall mounting and cantilevering systems when using the extensive range of accessories
- The large range of accessories allows constructing heavy-duty support systems

Article no.	W (mm)	H (mm)	T (mm)	L (mm)	
40004321	27	18	1,25	2.000	10 pc



MOUNTINGRAIL R30-15

WHY

- Efficient and quick fixing of one or more pipes
- Excellent for use as support when attaching air ducts
- Unlimited application possibilities for wall mounting and cantilevering systems when using the extensive range of accessories
- The large range of accessories allows constructing heavy-duty support systems

Article no.	W (mm)	H (mm)	T (mm)	L (mm)	
50000074	30	15	2,00	2.000	10 pc



CANTILEVER ARM R27-18

Article no.	W (mm)	H (mm)	T (mm)	L (mm)	
40003766	27	18	1,25	200	10 pc
40003767	27	18	1,25	300	10 pc
40003769	27	18	1,25	400	10 pc
40003770	27	18	1,25	500	10 pc



CANTILEVER ARM R30-15

Article no.	W (mm)	H (mm)	T (mm)	L (mm)	
40003758	30	15	2,00	200	10 pc
40003760	30	15	2,00	300	10 pc
40003762	30	15	2,00	400	10 pc
40003764	30	15	2,00	500	10 pc



MOUNTINGRAIL R30-30

WHY

- Efficient and quick fixing of one or more pipes
- Excellent for use as support when attaching air ducts
- Unlimited application possibilities for wall mounting and cantilevering systems when using the extensive range of accessories
- The large range of accessories allows constructing heavy-duty support systems

Article no.	W (mm)	H (mm)	T (mm)	L (mm)	
40005777	30	30	1,80	2.000	10 pc



MOUNTINGRAIL R35-20

WHY

- Efficient and quick fixing of one or more pipes
- Excellent for use as support when attaching air ducts
- Unlimited application possibilities for wall mounting and cantilevering systems when using the extensive range of accessories
- The large range of accessories allows constructing heavy-duty support systems

Article no.	W (mm)	H (mm)	T (mm)	L (mm)	
50000188	35	20	2,50	2.000	5 pc



MOUNTINGRAIL R41-21

WHY

- Efficient and quick fixing of one or more pipes
- Excellent for use as support when attaching air ducts
- Unlimited application possibilities for wall mounting and cantilevering systems when using the extensive range of accessories
- The large range of accessories allows constructing heavy-duty support systems

Article no.	W (mm)	H (mm)	T (mm)	L (mm)	
50004515	41	21	2,50	2.000	2 pc



MOUNTINGRAIL R41-41

WHY

- Efficient and quick fixing of one or more pipes
- Excellent for use as support when attaching air ducts
- Unlimited application possibilities for wall mounting and cantilevering systems when using the extensive range of accessories
- The large range of accessories allows constructing heavy-duty support systems

Article no.	W (mm)	H (mm)	T (mm)	L (mm)	
50004516	41	41	2,50	2.000	2 pc



CANTILEVER ARM R30-30

Article no.	W (mm)	H (mm)	T (mm)	L (mm)	
40005772	30	30	1,80	200	10 pc
40005773	30	30	1,80	300	10 pc
40005774	30	30	1,80	400	10 pc
40005775	30	30	1,80	500	10 pc
40005776	30	30	1,80	600	10 pc



CANTILEVER ARM R35-20

Article no.	W (mm)	H (mm)	T (mm)	L (mm)	
40003771	35	20	2,50	200	10 pc
40003773	35	20	2,50	300	10 pc
40003775	35	20	2,50	400	10 pc
40003777	35	20	2,50	500	10 pc
40005606	35	20	2,50	600	10 pc



CANTILEVER ARM R41-21

Article no.	W (mm)	H (mm)	T (mm)	L (mm)	
40003808	41	21	2,50	200	10 pc
40003809	41	21	2,50	300	10 pc
40003811	41	21	2,50	400	10 pc
40003812	41	21	2,50	500	10 pc
40005607	41	21	2,50	600	10 pc



CANTILEVER ARM R41-41

Article no.	W (mm)	H (mm)	T (mm)	L (mm)	
40003790	41	41	2,50	200	10 pc
40003791	41	41	2,50	300	10 pc
40003795	41	41	2,50	400	10 pc
40003796	41	41	2,50	500	10 pc
40003798	41	41	2,50	600	10 pc



ROFIX HEAVY DUTY CANTILEVER ARM R30-30

Article no.	W rail (mm)	H rail (mm)	T rail (mm)	L rail (mm)	Icon
40005783	30	30	1,80	200	1 pc
40005784	30	30	1,80	300	1 pc
40005785	30	30	1,80	400	1 pc
40005786	30	30	1,80	500	1 pc
40005787	30	30	1,80	600	1 pc
40005788	30	30	1,80	700	1 pc
40005789	30	30	1,80	800	1 pc
40005830	30	30	1,80	900	1 pc



VERTICAL CANTILEVER ARM R41-21

Article no.	W (mm)	H (mm)	T (mm)	L (mm)	Icon
40005617	41	21	2,50	200	5 pc
40005618	41	21	2,50	300	5 pc
40005619	41	21	2,50	400	5 pc
40005620	41	21	2,50	500	5 pc
40005621	41	21	2,50	600	5 pc



WALLFIXATION MOUNTINGRAIL

Article no.	Description	Icon
40003453	for mountingrail 30x15	10 pc
40003452	for mountingrail 35x20	10 pc
40003451	for mountingrail 41x41	10 pc



BEAM CLAMP

Article no.	Icon	Ø M	Description	Icon
50000171		M8		50 pc
50000172		M10		50 pc
50000173		M12		50 pc
50002523		M9	without thread	50 pc
50002524		M11	without thread	50 pc
50002525		M13	without thread	50 pc

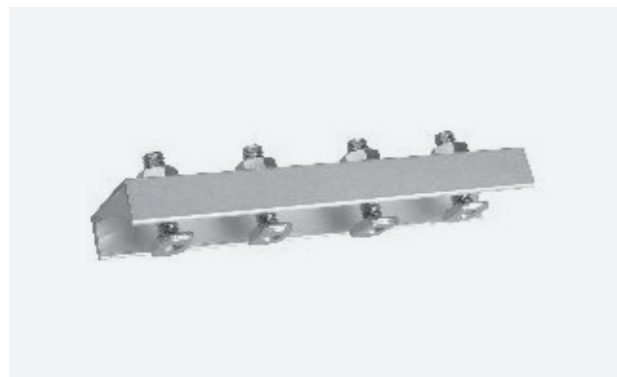

U-CONNECTION MOUNTINGRAIL CANTILEVER ARM

Article no.	Description	Icon
40003447	for mountingrail 30x15	10 pc
40003446	for mountingrail 35x20	10 pc
40003445	for mountingrail 41x41	10 pc



CONNECTION MOUNTINGRAIL CANTILEVER ARM

Article no.	Description	Icon
40003450	for mountingrail 35x20	25 pc
40003449	for mountingrail 41x41	25 pc



STRUT BEAM CLAMP

Article no.	Description	Icon
40003448	for mountingrail 41x41	50 pc



SLIDE NUT

Article no.	Icon	Ø M	Description	Icon
50000168		M6	for mountingrail or cantilever arm 30x15, 30x20, 27x18	100 pc
50000169		M8	for mountingrail or cantilever arm 30x15, 30x20, 27x18	100 pc
50000170		M10	for mountingrail or cantilever arm 30x15, 30x20, 27x18	100 pc



SLIDE NUT FOR RAIL & CANTILEVER ARM 41X41

Article no.	H (mm)	Ø M		
50000908	8	M8	without spring	100 pc
50000909	9	M10	without spring	100 pc
50000910	9	M12	without spring	100 pc
50000429	6,5	M6	with spring	100 pc
50000428	8	M8	with spring	100 pc



WASHER

Article no.	Ø M	Ø (mm)	
40000122	M6	18	100 pc
50002063	M6	25	200 pc
40000123	M8	25	100 pc
40000126	M8	40	100 pc
40000124	M10	30	100 pc
40000127	M10	40	100 pc
50002064	M12	30	100 pc
40000178	M12	40	100 pc



THREADED ROD 4.8

Article no.	Ø M	L (mm)	
50000203	M6	1.000	100 pc
50000175	M8	1.000	25 pc
50000176	M10	1.000	25 pc
50000177	M12	1.000	20 pc
50002120	M16	1.000	10 pc



TRAPEZOIDAL HANGER

Article no.	Ø M	
40003743	M8	50 pc
50004526	M10	50 pc



HEXAGONAL NUT

Article no.	Ø M	
40000188	M6	100 pc
40000119	M8	100 pc
40000120	M10	100 pc
40000121	M12	100 pc



LONG NUT

Article no.	Ø M	L (mm)	
50000004	M6	18	100 pc
50000005	M8	24	100 pc
50000006	M10	30	100 pc
50000007	M12	36	50 pc

HAMMERHEAD BOLT FOR R 30X15, 30X20, 30X30

Article no.	Ø M	L (mm)	Description	
40000110	M8	40	Hammer head bolt 30x15, 30x20, 30x30 M8 x 40	100 pc
40000111	M8	50	Hammer head bolt 30x15, 30x20, 30x30 M8 x 50	100 pc
40000112	M8	60	Hammer head bolt 30x15, 30x20, 30x30 M8 x 60	100 pc
40000115	M10	40	Hammer head bolt 30x15, 30x20, 30x30 M10 x 40	100 pc
40000116	M10	50	Hammer head bolt 30x15, 30x20, 30x30 M10 x 50	100 pc
40000117	M10	60	Hammer head bolt 30x15, 30x20, 30x30 M10 x 60	100 pc

HAMMERHEAD BOLT FOR 41X21 AND 41X41

Article no.	Ø M	L (mm)	Description	
40004720	M8	40	Hammer head bolt for 41x21, 41x41 M8 x 40	100 pc
40004587	M8	50	Hammer head bolt for 41x21, 41x41 M8 x 50	100 pc
40004835	M8	60	Hammer head bolt for 41x21, 41x41 M8 x 60	100 pc
40004960	M10	40	Hammer head bolt for 41x21, 41x41 M10 x 40	100 pc
40004935	M10	50	Hammer head bolt for 41x21, 41x41 M10 x 50	100 pc

**MOUNTING
ACCESSORIES:
SECURE EVERY
CONNECTION WITH
FLEXIBILITY**

03. MOUNTING ACCESSORIES

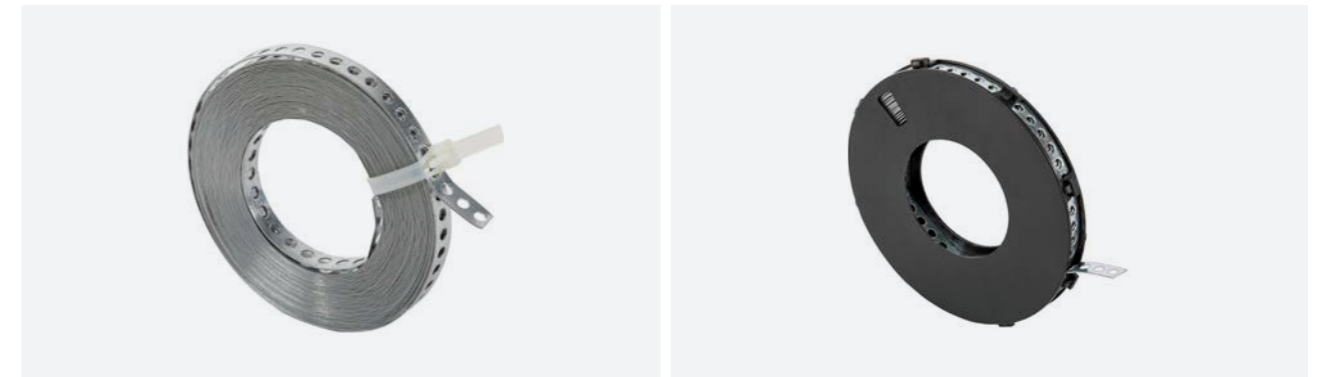

PERFOBAND GALVA 12MM

Article no.	W & T (mm)	L (m)	Hole pattern	Unit packing	
40005300	12 x 0,7	3	5,2mm per 9mm	RTW	10 pc/strap
40005302	12 x 0,7	5	5,2mm per 9mm	RTW	10 pc/strap
40005304	12 x 0,7	10	5,2mm per 9mm	RTW	10 pc/strap
40005306	12 x 0,7	20	5,2mm per 9mm	RTW	10 pc/strap
40005308	12 x 0,7	25	5,2mm per 9mm	RTW	10 pc/strap
40005358	12 x 0,7	10	5,2mm per 9mm	Cassette	10 pc/strap
40005553	12 x 0,7	20	5,2mm per 9mm	Cassette	10 pc/strap
40005554	12 x 0,7	25	5,2mm per 9mm	Cassette	10 pc/strap

* RTW = Releasable Tie Wrap

PERFOBAND GALVA 17MM

Article no.	W & T (mm)	L (m)	Hole pattern	Unit packing	
40005316	17 x 0,7	3	6,8mm - 3,2mm per 15mm	RTW	10 pc/strap
40005318	17 x 0,7	5	6,8mm - 3,2mm per 15mm	RTW	10 pc/strap
40005320	17 x 0,7	10	6,8mm - 3,2mm per 15mm	RTW	10 pc/strap
40005322	17 x 0,7	20	6,8mm - 3,2mm per 15mm	RTW	10 pc/strap
40005324	17 x 0,7	25	6,8mm - 3,2mm per 15mm	RTW	10 pc/strap
40005364	17 x 0,7	10	6,8mm - 3,2mm per 15mm	Cassette	10 pc/strap
40005366	17 x 0,7	20	6,8mm - 3,2mm per 15mm	Cassette	10 pc/strap
40005368	17 x 0,7	25	6,8mm - 3,2mm per 15mm	Cassette	10 pc/strap
40005556	17 x 0,7	3	6,5mm x 11 - 2,8mm per 20mm	RTW	10 pc/strap
40005557	17 x 0,7	5	6,5mm x 11 - 2,8mm per 20mm	RTW	10 pc/strap
40005558	17 x 0,7	10	6,5mm x 11 - 2,8mm per 20mm	RTW	10 pc/strap
40005559	17 x 0,7	20	6,5mm x 11 - 2,8mm per 20mm	RTW	10 pc/strap
40005560	17 x 0,7	25	6,5mm x 11 - 2,8mm per 20mm	RTW	10 pc/strap
40005561	17 x 0,7	10	6,5mm x 11 - 2,8mm per 20mm	Cassette	10 pc/strap
40005562	17 x 0,7	20	6,5mm x 11 - 2,8mm per 20mm	Cassette	10 pc/strap
40005563	17 x 0,7	25	6,5mm x 11 - 2,8mm per 20mm	Cassette	10 pc/strap

* RTW = Releasable Tie Wrap



PERFOBAND GALVA 25MM

Article no.	W & T (mm)	L (m)	Hole pattern	Unit packing	
40005338	25 x 0,7	3	8,5mm 15mm	RTW	10 pc/strap
40005340	25 x 0,7	5	8,5mm 15mm	RTW	10 pc/strap
40005342	25 x 0,7	10	8,5mm 15mm	RTW	10 pc/strap
40005344	25 x 0,7	20	8,5mm 15mm	RTW	10 pc/strap
40005346	25 x 0,7	25	8,5mm 15mm	RTW	10 pc/strap
40005404	25 x 0,7	10	8,5mm 15mm	Cassette	10 pc/strap

* RTW = Releasable Tie Wrap



PERFOBAND PLASTIFIED GREY 14MM

Article no.	W & T (mm)	L (m)	Hole pattern	Unit packing	
40005310	14 x 2,6	3	5,2mm per 9mm	RTW	10 pc/strap
40005312	14 x 2,6	5	5,2mm per 9mm	RTW	10 pc/strap
40005314	14 x 2,6	10	5,2mm per 9mm	RTW	10 pc/strap
40005572	14 x 2,6	20	5,2mm per 9mm	RTW	10 pc/strap
40005573	14 x 2,6	25	5,2mm per 9mm	RTW	10 pc/strap
40005374	14 x 2,6	10	5,2mm per 9mm	Cassette	10 pc/strap
40005376	14 x 2,6	20	5,2mm per 9mm	Cassette	10 pc/strap
40005375	14 x 2,6	25	5,2mm per 9mm	Cassette	10 pc/strap
40005574	14 x 2,6	3	Unperforated	RTW	10 pc/strap
40005575	14 x 2,6	5	Unperforated	RTW	10 pc/strap
40005576	14 x 2,6	10	Unperforated	RTW	10 pc/strap
40005579	14 x 2,6	10	Unperforated	Cassette	10 pc/strap
40005578	14 x 2,6	25	Unperforated	RTW	10 pc/strap
40005579	14 x 2,6	10	Unperforated	Cassette	10 pc/strap

* RTW = Releasable Tie Wrap

PERFOBAND PLASTIFIED GREY 27MM

Article no.	W & T (mm)	L (m)	Hole pattern	Unit packing	
40005348	27 x 2,6	3	8,5mm 15mm	RTW	10 pc/strap
40005350	27 x 2,6	5	8,5mm 15mm	RTW	10 pc/strap
40005352	27 x 2,6	10	8,5mm 15mm	RTW	10 pc/strap
40005600	27 x 2,6	3	Unperforated	RTW	10 pc/strap
40005601	27 x 2,6	5	Unperforated	RTW	10 pc/strap
40005602	27 x 2,6	10	Unperforated	RTW	10 pc/strap
40005602	27 x 2,6	10	Unperforated	RTW	10 pc/strap

* RTW = Releasable Tie Wrap

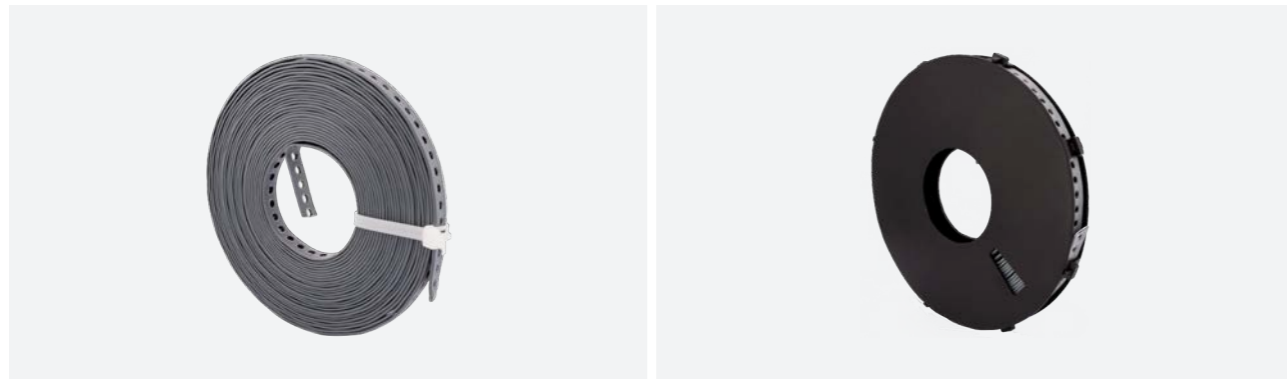

PERFOBAND PLASTIFIED GREY 19MM

Article no.	W & T (mm)	L (m)	Hole pattern	Unit packing	
40005326	19 x 2,6	3	6,5mm per 15mm	RTW	10 pc/strap
40005328	19 x 2,6	5	6,5mm per 15mm	RTW	10 pc/strap
40005330	19 x 2,6	10	6,5mm per 15mm	RTW	10 pc/strap
40005582	19 x 2,6	20	6,5mm per 15mm	RTW	10 pc/strap
40005583	19 x 2,6	25	6,5mm per 15mm	RTW	10 pc/strap
40005384	19 x 2,6	10	6,5mm per 15mm	Cassette	10 pc/strap
40005584	19 x 2,6	3	6,5mm x 11 - 2,8mm per 20mm	RTW	10 pc/strap
40005585	19 x 2,6	5	6,5mm x 11 - 2,8mm per 20mm	RTW	10 pc/strap
40005586	19 x 2,6	10	6,5mm x 11 - 2,8mm per 20mm	RTW	10 pc/strap
40005587	19 x 2,6	20	6,5mm x 11 - 2,8mm per 20mm	RTW	10 pc/strap
40005588	19 x 2,6	25	6,5mm x 11 - 2,8mm per 20mm	RTW	10 pc/strap
40005589	19 x 2,6	10	6,5mm x 11 - 2,8mm per 20mm	Cassette	10 pc/strap
40005592	19 x 2,6	3	Unperforated	RTW	10 pc/strap
40005593	19 x 2,6	5	Unperforated	RTW	10 pc/strap
40005594	19 x 2,6	10	Unperforated	RTW	10 pc/strap
40005595	19 x 2,6	20	Unperforated	RTW	10 pc/strap
40005596	19 x 2,6	25	Unperforated	RTW	10 pc/strap
40005597	19 x 2,6	10	Unperforated	Cassette	10 pc/strap
40005594	19 x 2,6	10	Unperforated	RTW	10 pc/strap
40005595	19 x 2,6	20	Unperforated	RTW	10 pc/strap
40005596	19 x 2,6	25	Unperforated	RTW	10 pc/strap
40005597	19 x 2,6	10	Unperforated	Cassette	10 pc/strap

* RTW = Releasable Tie Wrap



FIXPIN DRIVE NAIL

Article no.	Description	
50000745	Drive nail 18x10x4mm	500 pc
50002594	Drive nail 18x10x4mm - 10mm collar	200 pc



FIXPIN TOOL

Article no.	Description	
50000746	Iron setting tool with grip	1 pc



METRIC EYE BOLT

Article no.	Ø (mm)	L (mm)	
50000109	M6	25	100 pc
50000110	M8	30	100 pc



FLAT EYE SCREW

Article no.	Ø (mm)	L (mm)	
50000111	M6	50	100 pc



NYLON PLUG

Article no.	Ø (mm)	Icon
50000086	6	100 pc
50000087	8	100 pc
50000088	10	50 pc



NYLON PLUG WITH COLLAR

WHY

- For fastening in hollow walls

Article no.	Ø (mm)	Icon
50000089	6	100 pc
50000090	8	100 pc
50000091	10	50 pc



SPEEDPLUG

Article no.	Ø (mm)	L (mm)	Icon
50002613	M8	45	100 pc

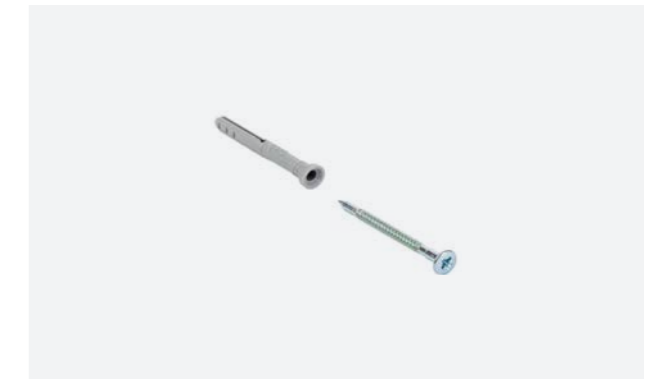

NAIL-PLUG FLAT HEADED

Article no.	Ø (mm)	L (mm)	Icon
50001819	M6	50	200 pc

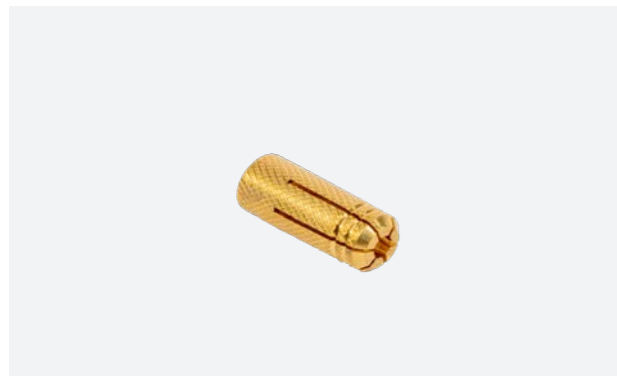

BRASS PLUG

WHY

- For quick mounting e.g. in concrete, walls or brick

Article no.	Ø (mm)	Icon
50000081	M6	100 pc
50000082	M8	50 pc
50000083	M10	50 pc
50000084	M12	25 pc



UNIVERSAL FASTENING SET

Article no.	Ø (mm)	L (mm)	Icon
40000104	8	50	100 SE/4
40000105	8	60	100 SE/4
40003473	8	60	200 SE/2



TOILET FASTENING SET

Article no.	Description	L (mm)	Icon
50001891	White	M6x70	50 pc
50001892	Chrome	M6x70	50 pc



SINK FASTENING SET

Article no.	Ø (mm)	L (mm)	Icon
40000101	M8	110	50 pc
40000103	M10	120	50 pc
40000100	M10	140	50 pc



PUMP SUPPORT WITH BRIDGE

Article no.	W (mm)	H (mm)	T (mm)	L (mm)	
40003472	30	30	2	300	12 SE/2
40001370	30	30	2	400	12 SE/2



PUMP SUPPORT WITHOUT BRIDGE

Article no.	W (mm)	H (mm)	T (mm)	L (mm)	
40001445	30	30	2	400	12 SE/2

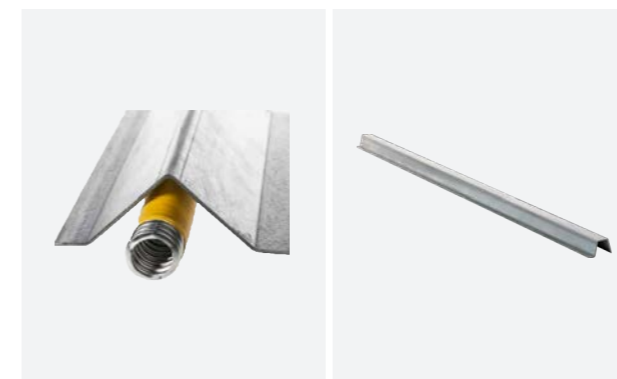

COVERFIX FLOOR

Article no.	Description	L (mm)	
40004775	DN15+16 (max. Ø 22mm)	1.000	1 pc
40004776	DN20 (max. Ø 28mm)	1.000	1 pc
40003640	DN25 (max. Ø 35,1mm)	1.000	1 pc
40003641	DN32 (max. Ø 42,3mm)	1.000	1 pc
40003642	DN40 (max. Ø 56mm)	1.000	1 pc
40003643	DN50 (max. Ø 70mm)	1.000	1 pc
40005511	Max. DN20 (max. Ø 32mm)	1.200	1 pc
40005512	Max. DN32 (max. Ø 42mm)	1.200	1 pc



COVERFIX CURVE

Article no.	Description	
40003644	DN15+16 (max. ø 22mm)	1 pc
40003645	DN20 (max. ø 28mm)	1 pc
40003646	DN25 (max. ø 35,1mm)	1 pc
40003647	DN32 (max. ø 42,3mm)	1 pc
40003648	DN40 (max. ø 56mm)	1 pc
40003649	DN50 (max. ø 70mm)	1 pc



UNIVERSAL PUMP SUPPORT WITH FASTENING SET

Article no.	W (mm)	H (mm)	T (mm)	L (mm)	
40003608	249	152	3	283	1 pc



ANGLE BRACKET SET FOR SINK RAL 9016

Article no.	W (mm)	H (mm)	T (mm)	L (mm)	
40004824	30	200	3	400	250 pc

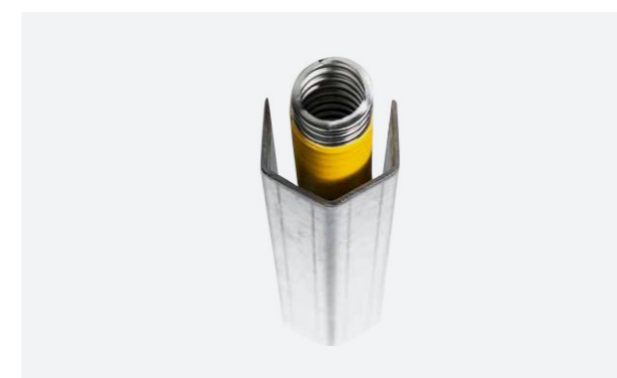

COVERFIX WALL

Article no.	Description	L (mm)	
40004994	DN15+16 (max. Ø 22mm)	1.000	1 pc
40004995	DN20 (max. Ø 28mm)	1.000	1 pc
40005031	DN25 (max. Ø 35,1mm)	1.000	1 pc



COVERFIX WALL CLAMP

Article no.	Description	
40002161	Clamp for Coverfix Wall DN15+16	50 pc
40002160	Clamp for Coverfix Wall DN20	50 pc
40005032	Clamp for Coverfix Wall DN25	50 pc



DOUBLE THREAD SCREW

Article no.	Ø (mm)	L (mm)		
50000095	M8	50	100 pc	1.800 pc
50000743	M8	60	100 pc	1.600 pc
50000096	M8	80	100 pc	1.200 pc
50000632	M8	90	100 pc	1.000 pc
50000097	M8	100	100 pc	1.000 pc
50000927	M8	110	100 pc	800 pc
50000098	M8	120	100 pc	800 pc
50000099	M8	140	100 pc	600 pc
50000815	M8	150	100 pc	600 pc
50000816	M8	160	100 pc	600 pc
50000817	M8	180	100 pc	400 pc
50000926	M8	200	100 pc	400 pc
50000100	M10	50	100 pc	1.000 pc
50000101	M10	80	100 pc	800 pc
50000102	M10	100	100 pc	600 pc
50000103	M10	120	100 pc	400 pc
50000756	M10	140	50 pc	400 pc

EXPANSION VESSEL BRACKET

SPECIFICATIONS

- Painted in RAL 9016
- Extendable section is hot-dip galvanised
- 2x M6 set screw for extra rigidity
- Equipped with welding socket 4/4"
- Adjustable wall distance (min. 150mm - max. 225mm)



COMPLETE SET CONSISTS OF

- 1x painted bracket RAL 9016
- 3x DIN571 wood screw M8x60
- 3x nylon plug F10

Article no.	Description		
40005625	Normal (150-225)	1pc	10 pc
40005922	Big (180-255)	1pc	10 pc



SINGLE COLLECTORBRACKET

WHY

- Mounting bracket for heating or sanitary manifold

Article no.	Description	
40005494	Single bracket with curved clamp	50 SE/2
40005495	Single bracket with straight clamp	50 SE/2



DOUBLE COLLECTORBRACKET

WHY

- Mounting bracket for heating or sanitary manifold

Article no.	Description	
40005492	Double bracket with curved clamp	25 SE/2
40005493	Double bracket with straight clamp	25 SE/2



COLLECTORBRACKET FOOT

WHY

- The perfect solution when there is not a wall (yet) to mount your collectorbracket

SPECIFICATIONS

- Rail foot 30x30x2mm
- Length 600mm
- Galvanized
- 2 grey protection caps included
- 4 slide nuts included
- 6 screws and nuts included

Article no.	Description	
40005866	Collectorbracket foot	1 set/2
40005867	Collectorbracket foot with collectorbracket round	1 set/2
40005868	Collectorbracket foot with collectorbracket square	1 set/2

UNIT MOUNTINGS & SUPPORTS FOR RELIABLE MOUNTING SOLUTIONS

04. UNIT MOUNTINGS



UNIT FLOOR STAND

WHY

- Perfect for units that need to be placed on the ground
- Variable dimensions possible with one stand
- Adjustable feet for uneven underground
- Dampers included for maximum noise and vibration reduction

Article no.	Description	
40005790	Unit floor stand galvanized	1pc
40005791	Unit floor stand white	1pc
40005946	Unit floor stand black	1pc



UNIT WALL SUPPORT WITH BACKRAIL

WHY

- A strong, esthetic solution for your mounting your unit
- Available in 3 versions, to offer an invisible solution
- Dampers included for maximum noise and vibration reduction

Article no.	Description	
40005905	Unit wall support with backrail L500 galvanized	1 set/2
40005941	Unit wall support with backrail L500 white	1 set/2
40005942	Unit wall support with backrail L500 black	1 set/2



UNIT WALL SUPPORT TRIANGLE

WHY

- A rigid solution for your mounting your unit
- Available in 3 versions, to offer your suitable solution
- Dampers included for maximum noise and vibration reduction

Article no.	Description	
40005943	Unit triangle wall support L500 galvanized	1 set/2
40005944	Unit triangle wall support L500 white	1 set/2
40005945	Unit triangle wall support L500 black	1 set/2

WALL BRACKETS & SUPPORTS FOR RELIABLE MOUNTING SOLUTIONS

05. WALL BRACKETS



U2

WHY

- For compact radiators without lugs
- The U-shape of the console provides full support against the wall
- Extremely fast and easy to assemble
- Wall distance of 33mm or 43mm
- Easy disassembly

COMPLETE SET CONSISTS OF

- 2x wall bracket (2 wall distances)
- 2x head with pre-assembled grill clamp
- 2x screw cover M6 (Ref. 40000493)
- 1x dismantling hook
- 4x DIN571 wood screw M8x60
- 4x nylon plug F10 (only to be used in full limestone or concrete C25 to ensure a minimum pull-out force of 5kN)

H (mm)	Grill clamp 9mm	
300	40000901	25/SE2
400	40000902	25/SE2
500	40000903	25/SE2
600	40000904	25/SE2
700	40000923	20/SE2
800	40001288	20/SE2
900	40000905	20/SE2

ATTENTION with radiator length L > 1.600mm Rofix advises to use at least 3 brackets



TRIAS S40-50-60

WHY

- For standard and compact radiators without lugs
- Always delivered with both standard and grill clamp
- 3 wall distances possible: 40, 50 or 60mm

COMPLETE SET CONSISTS OF

- 2x wall bracket (3 wall distances)
- 2x painted top clamp RAL 9016 for standard radiators
- 2x painted top clamp RAL 9016 for compact radiators (pre-assembled)
- 2x screw cover M6 (Ref. 40000493)
- 4x DIN571 wood screw M8x60
- 4x nylon plug F10 (only to be used in full limestone or concrete C25 to ensure a minimum pull-out force of 5kN)

H (mm)	Grill clamp 9mm	
300	40001119	20/SE2
400	40001120	20/SE2
500	40001121	20/SE2
600	50001461	20/SE2
700	40001122	20/SE2
900	50001462	20/SE2

ATTENTION with radiator length L > 1.600mm Rofix advises to use at least 3 brackets



TRIAS S50-60-70

WHY

- For standard and compact radiators without lugs
- Always delivered with both standard and grill clamp
- 3 wall distances possible: 50, 60 or 70mm

COMPLETE SET CONSISTS OF

- 2x wall bracket (3 wall distances)
- 2x painted top clamp RAL 9016 for standard radiators (pre-assembled)
- 2x painted top clamp RAL 9016 for compact radiators
- 2x screw cover M6 (Ref. 40000493)
- 4x DIN571 wood screw M8x60
- 4x nylon plug F10 (only to be used in full limestone or concrete C25 to ensure a minimum pull-out force of 5kN)

H (mm)	Grill clamp 6,5 mm	Grill clamp 8 mm	Grill clamp 9 mm	Grill clamp 13 mm	
300	40001296	50001795	50001811	40001303	20/SE2
400	40001297	50001796	50001812	40001304	20/SE2
450	50001810	-	-	-	20/SE2
500	40001298	50001797	50001813	40001305	20/SE2
600	40001299	50001798	50001814	40001306	20/SE2
700	40001300	50001799	50001815	40001307	20/SE2
900	40001302	50001800	50001816	40001309	20/SE2

ATTENTION with radiator length L > 1.600mm Rofix advises to use at least 3 brackets



TRIAS VARIO S40-50-60

WHY

- For compact radiators without lugs height 300, 400, 500 or 600mm
- 3 wall distances possible: 40, 50 or 60mm
- Max. = 120kg/bracket

COMPLETE SET CONSISTS OF

- 2x wall bracket (3 wall distances)
- 2x painted top clamp RAL 9016 for compact radiators
- 2x screw cover M6 (Ref. 40000493)
- 4x DIN571 wood screw M6x50
- 4x nylon plug F8
- 4x stud M6x8
- 4x square nut M6x10x3.0
- 2x square nut M6x13x2.5
- 2x stud M6x12

H (mm)	Grill clamp 9mm	
300 - 400 - 500 - 600	40001208	20/SE2

ATTENTION with radiator length L > 1.600mm Rofix advises to use at least 3 brackets



TRIAS HYGIENIC

WHY

- 100mm between the wall and the radiator
- offers you easy acces for cleaning
- High level of security
- Easy and simple installation guaranteed

COMPLETE SET CONSISTS OF

- 2 consoles galvanized
- 2 grill clamps in RAL 9016
- 2 M6 covercaps
- 4 screws M8x60
- 4 nylon plugs F10

H (mm)	Grill clamp 9mm	
300	40004374	15/SE2
400	40004376	15/SE2
500	40004378	15/SE2
600	40004381	15/SE2
900	40004385	15/SE2

ATTENTION with radiator length L > 1.600mm Rofix advises to use at least 3 brackets



TRIAS HYGIENIC WHITE

WHY

- 100mm between the wall and the radiator
- offers you easy acces for cleaning
- High level of security
- Easy and simple installation guaranteed

COMPLETE SET CONSISTS OF

- 2 consoles galvanized and painted in RAL 9016
- 2 grill clamps in RAL 9016
- 2 M6 covercaps
- 4 screws M8x60
- 4 nylon plugs F10
- 2x stud M6x12

H (mm)	Grill clamp 9mm	
300	40005800	15/SE2
400	40005801	15/SE2
500	40005803	15/SE2
600	40005804	15/SE2
900	40005805	15/SE2

ATTENTION with radiator length L > 1.600mm Rofix advises to use at least 3 brackets

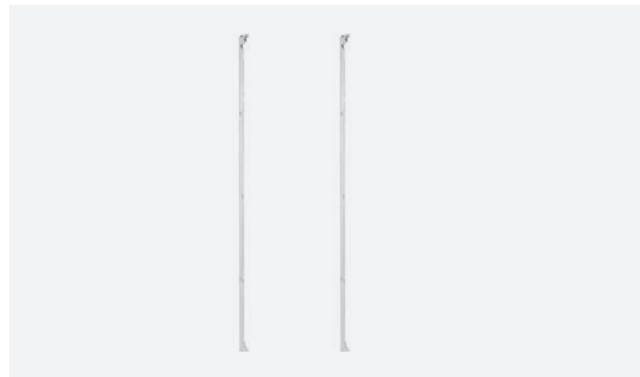

8-P SUPERSAFE

WHY

- Meets Class 4 VDI6036 Norm
- The best and the safest bracket for vertical radiators in the market
- Suitable for use in exceptional conditions with extraordinary loads
- For vertical radiators type 20 or higher, almost all brands
- The console is variably adjustable for radiators with heights from 1.500mm to 2.200mm
- Fixed wall distance of 33mm
- For compact vertical radiators: select side holder with S-clamp
- For standard vertical radiators: select side holder with Standard-clamp
- ETA 07/0121 certified wood screws and plugs suitable for various anchoring substrates
- Painted wall bracket RAL 9016

COMPLETE SET CONSISTS OF

- 2x wall bracket
- 4x side holder with S-clamp or Standard-clamp
- 8x wood screw M7x85
- 8x nylon plug F10x80

Article no.	Description	
40005280	8PSS bracket with head	1 pc
40005291	Assembly set 8PSS bracket - S-clamp	1 set
40005293	Assembly set 8PSS bracket - Standard clamp	1 set
40005292	8PSS complete set - S-clamp	1 set
40005294	8PSS complete set - Standard clamp	1 set



ALU RADIATOR BRACKET

Article no.	Description	
40005780	Alu radiator bracket H500	20/se2

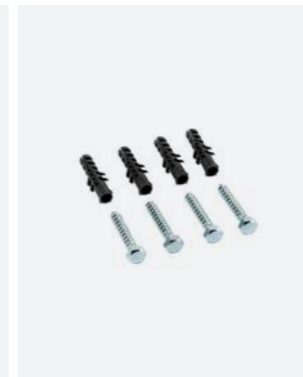

FIX-MATIC

WHY

- Ideal bracket for radiators with lugs
- Extremely fast and safe assembly
- Solid bracket with lift-out protection
- Unlocking only possible with tools
- Anti-theft possible by additional locking screw
- Fixed wall distance of 29mm

COMPLETE SET CONSISTS OF

- 2x wall bracket with mounted insulation clips
- 4x DIN571 wood screw M8x50
- 4x nylon plug F10 (only to be used in full limestone or concrete C25 to ensure a minimum pull-out force of 5kN)

H (mm)	Dure Radson Superia	Korado	Stelrad Thermrad	
300	40000366	40000463	40000397	25/SE2
400	40000367	40000464	40000398	25/SE2
450	40000398	-	-	25/SE2
500	40000368	40000465	40000399	25/SE2
600	40000369	40000466	40000400	25/SE2
700	40000370	-	40000401	25/SE2
750	40000401	-	-	25/SE2
900	40000371	40000467	40000402	25/SE2

ATTENTION on each vertical set of 2 radiator lugs, one console is provided

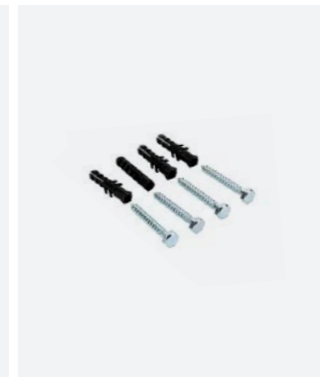

L-BRACKET

WHY

- Suitable for radiators with lugs
- Wall distance of 13mm or 39mm

COMPLETE SET CONSISTS OF

- 2x wall bracket with mounted insulation clips
- 4x DIN571 wood screw M8x50
- 4x nylon plug F10 (only to be used in full limestone or concrete C25 to ensure a minimum pull-out force of 5kN)

H (mm)	Dure Radson Superia	Stelrad Thermrad	
300	40001776	40000024	25/SE2
400	40000038	40000039	25/SE2
450	40000039	-	25/SE2
500	40000040	40000025	25/SE2
600	40000041	40000026	25/SE2
700	40000018	40000042	25/SE2
750	40000042	-	25/SE2
900	40000043	40000027	25/SE2

ATTENTION on each vertical set of 2 radiator lugs, one console is provided



L-BRACKET VDI CLASS 3

WHY

- Aesthetically nice concealed console that still achieves VDI class 3
- Provided with the necessary certification
- Best VDI Class 3 price-performance solution on the market
- Suitable for radiators with lugs

COMPLETE SET CONSISTS OF

- 2x wall bracket with mounted insulation clips
- 2x pre-mounted TDB-clip (necessary)
- 4x DIN571 wood screw M8x50
- 4x nylon plug F10 (only to be used in full limestone or concrete C25 to ensure a minimum pull-out force of 5kN)

H (mm)	Dure Radson Superia	Stelrad Thermrad	
300	40005641	40005649	25/SE2
400	40005642	40005643	25/SE2
450	40005643	-	25/SE2
500	40005644	40004650	25/SE2
600	40005645	40005651	25/SE2
700	40005646	40005647	25/SE2
750	40005647	-	25/SE2
900	40005648	40005652	25/SE2

ATTENTION on each vertical set of 2 radiator lugs, one console is provided



SCREW-ON SET

WHY

- Complete set for the mounting of 1 panel radiator
- Universal radiator mounting set

COMPLETE SET CONSISTS OF

- 2x screw on support (adjustment range to the wall: min. 45mm to max. 68mm)
- 2x side bracket with iso (adjustment range to the wall: min. 43mm to max. 62mm)
- 4x wood screw M8x60
- 4x nylon plug F10

Article no.	Description	
50000942	Screw-on set	25 SE/2
50000944	Screw-on set with M8 washers	25 SE/2



ANGLE BRACKET SET TYPE 2003

WHY

- Suitable for radiators with lugs
- Universal for all radiator heights
- With adjustable plastic distance holder
- 3 possible wall distances: 13mm, 23mm or 33mm

COMPLETE SET CONSISTS OF

- 2x angle bracket with silent block
- 2x wood screw M8x60
- 2x nylon plug F10
- 2x distance holder

Article no.	Description	
50000030	Angle bracket set type 100	25 SE/2



ANGLE BRACKET SET TYPE 100

WHY

- Suitable for radiators with lugs
- Universal for all radiator heights
- With adjustable plastic distance holder
- 4 possible wall distances: 19mm, 30mm, 37mm or 48mm

COMPLETE SET CONSISTS OF

- 2x angle bracket with silent block
- 2x wood screw M8x50
- 2x nylon plug F10
- 2x wood screw M6x50
- 2x nylon plug F8
- 2x distance holder

Article no.	Description	
50000030	Angle bracket set type 100	25 SE/2

**FLOOR BRACKETS:
STRONG AND
RELIABLE
ANCHORS FOR
ANY PROJECT**

06. FLOOR BRACKETS



EXPANDER

WHY

- Suitable for most radiators (type 20-21-22-33) with maximum height of 900 mm
- Even for radiators with a centre connection
- Easy to assemble; can even be mounted while the packaging is still around the radiator
- Aesthetically concealed
- Expander finished floor adjustable in height from 130mm to 200mm
- Expander unfinished floor adjustable in height from 285mm to 355mm

COMPLETE SET CONSISTS OF

- 2x complete floor bracket
- DIN571 wood screw M8x60 (qty depends on the version)
- Nylon plug F10 (qty depends on the version)
- Screw cover M6 (Ref. 40000493) (qty depends on the version)
- 2x bottom cover (except for ref. 40001594)

EXPANDER FINISHED FLOOR

Article no.	Description	
40001352	Expander Type 79-91	1 SE/2
40001584	Expander Type 85-97	1 SE/2
40004741	Expander Type 20/21 - Korado	1 SE/2
40004742	Expander Type 22/30/33/44 - Korado	1 SE/2
40005002	Expander Type 21 - Radson E-flow	1 SE/2
40004806	Expander Type 22 - Radson E-flow	1 SE/2
40005453	Expander Type 21 - Van Marcke Origine	1 SE/2
40005454	Expander Type 22 - Van Marcke Origine	1 SE/2
40005542	Expander Type 21 - Stelrad	1 SE/2
40005541	Expander Type 22 - Stelrad	1 SE/2
40005544	Expander Type 21 - Brugman	1 SE/2
40005545	Expander Type 22 - Brugman	1 SE/2

ATTENTION with radiator length L > 1.600mm Rofix advises to use at least 3 brackets

EXPANDER UNFINISHED FLOOR

Article no.	Description	
40001594	Expander screed Type 85-97	1 SE/2
40005624	Expander screed Type 20/21 - Brugman	1 SE/2
40005546	Expander screed Type 22/30/33/44 - Brugman	1 SE/2
40005622	Expander screed Type 22 - Stelrad Thick	1 SE/2

ATTENTION with radiator length L > 1.600mm Rofix advises to use at least 3 brackets



UNISTAND FINISHED FLOOR

WHY

- Universal floor for radiator types 20-21-22-33 without centre connection
- For all heights from 300mm to 900mm
- Extremely stable and high load-bearing floor bracket
- Can be mounted while the packaging is still around the radiator
- Easy to assemble
- Unistand mini for H200

COMPLETE SET SE/2 CONSISTS OF

- 2x pre-assembled floor bracket
- 6x DIN571 wood screw M8x60
- 6x nylon plug F10
- 6x bolt cap M8 (Ref. 40000198)
- 4x screw cover M6 (Ref. 40000493)
- 2x bottom cover (except for ref. 40000769)

COMPLETE SET SE/1 CONSISTS OF

- 1x pre-assembled floor bracket
- 3x DIN571 wood screw M8x60
- 3x nylon plug F10
- 3x bolt cap M8 (Ref. 40000198)
- 2x screw cover M6 (Ref. 40000493)

Article no.	Description	
50002275	Unistand H200/2	12 SE/2
50001826	Unistand H300/2	12 SE/2
40003440	Unistand H300/1	24 SE/1

ATTENTION with radiator length L > 1.600mm Rofix advises to use at least 3 brackets



UNISTAND UNFINISHED FLOOR

COMPLETE SET SE/2 CONSISTS OF

- 2x pre-assembled floor bracket
- 6x DIN571 wood screw M8x60
- 6x nylon plug F10
- 6x bolt cap M8 (Ref. 40000198)
- 4x screw cover M6 (Ref. 40000493)
- 2x bottom cover (except for ref. 40000769)

Article no.	Description	
40000769	Unistand unfinished floor H300/2	12 SE/2
4000770	Unistand unfinished floor H300/1	24 SE/1

ATTENTION with radiator length L > 1.600mm Rofix advises to use at least 3 brackets



UNIFIX

WHY

- Universal floor brackets, even for radiators with a centre connection
- Max. radiator height: 300mm
- Can be mounted while the packaging is still around the radiator
- Easy to assemble
- Aesthetically concealed

COMPLETE SET CONSISTS OF

- 2x complete floor bracket
- 6x DIN571 wood screw M8x60
- 6x nylon plug F10
- 6x bolt cap M8 (Ref. 40000198)
- 4x screw cover M6 (Ref. 40000493)

Article no.	Description	
50000388	Unifix	1 SE/2

ATTENTION with radiator length L > 2.000mm Rofix advises to change to the Rofix Expander or Unistand

Article no.	Description	
50000824	Bottom cover for Unifix	24 PC



DUO FLOOR BRACKET WITH FASTENING SET

WHY

- Floor bracket at the height of your choice

COMPLETE SET CONSISTS OF

- 2x painted floor bracket RAL 9016
- 6x DIN571 wood screw M8x60
- 6x nylon plug F10
- 6x bolt cap M8 (Ref. 40000198)
- 2x cover standing tube (Ref. 40000180)

Article no.	Description	
40000484	Set of 2 floor brackets H250mm	6 SE/2
40000080	Set of 2 floor brackets H400mm	6 SE/2
40000081	Set of 2 floor brackets H500mm	6 SE/2
40000082	Set of 2 floor brackets H600mm	6 SE/2
40000083	Set of 2 floor brackets H700mm	6 SE/2
40000084	Set of 2 floor brackets H800mm	6 SE/2
40000085	Set of 2 floor brackets H900mm	6 SE/2
40000086	Set of 2 floor brackets H1.000mm	6 SE/2
40000087	Set of 2 floor brackets H1.100mm	6 SE/2
40000079	Set of 2 floor brackets H1.200mm	6 SE/2

ATTENTION with radiator length L > 1.600mm Rofix advises to use at least 3 brackets



DUO FLOOR BRACKET WITH INNER MOUNTINGSET TYPE II

WHY

- Floor bracket at the height of your choice
- For both standard and compact radiators

COMPLETE SET CONSISTS OF

- 2x painted floor bracket RAL 9016
- 6x DIN571 wood screw M8x60
- 6x nylon plug F10
- 6x bolt cap M8 (Ref. 40000198)
- 2x plastic bracket adjustable in width (from 58mm up to 86mm)
- 2x lower bracket with nylon silent block
- 4x screw cover M6 (Ref. 40000493)

Article no.	Description	
40000252	Set of 2 floor brackets H400mm	6 SE/2
40000256	Set of 2 floor brackets H500mm	6 SE/2
40000250	Set of 2 floor brackets H600mm	6 SE/2
40000253	Set of 2 floor brackets H700mm	6 SE/2
40000249	Set of 2 floor brackets H800mm	6 SE/2
40000254	Set of 2 floor brackets H900mm	6 SE/2
40000248	Set of 2 floor brackets H1.000mm	6 SE/2
40000255	Set of 2 floor brackets H1.100mm	6 SE/2
40000247	Set of 2 floor brackets H1.200mm	6 SE/2

ATTENTION with radiator length L > 1.600mm Rofix advises to use at least 3 brackets

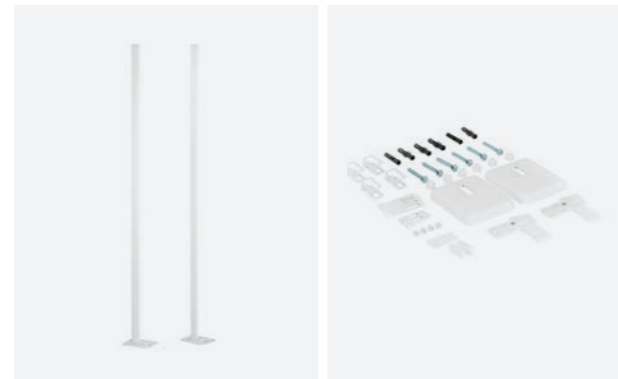

DUO FLOOR BRACKET H1.200MM WITH UNIVERSAL FIXATION SET

WHY

- Universal standpipe set
- For both standard and compact radiators
- The floor bracket can be shortened to the desired

COMPLETE SET CONSISTS OF

- 2x painted floor bracket RAL 9016
- 6x DIN571 wood screw M8x60
- 6x nylon plug F10
- 6x bolt cap M8 (Ref. 40000198)
- 2x cover floor bracket (Ref. 40000180)
- 2x bottom cover for Rofix floor bracket (Ref. 50000037)
- 4x painted floor bracket clamps RAL 9016
- 4x painted support key long RAL 9016
- 2x painted support key short RAL 9016
- 4x nylon silent block for support key
- 2x plastic bracket adjustable in width (from 33mm up to 66mm)
- 8x screw cover M6 (Ref. 40000493)

Article no.	Description	
40004743	Set of 2 floor brackets H1.200mm	6 SE/2

ATTENTION with radiator length L > 1.600mm Rofix advises to use at least 3 brackets

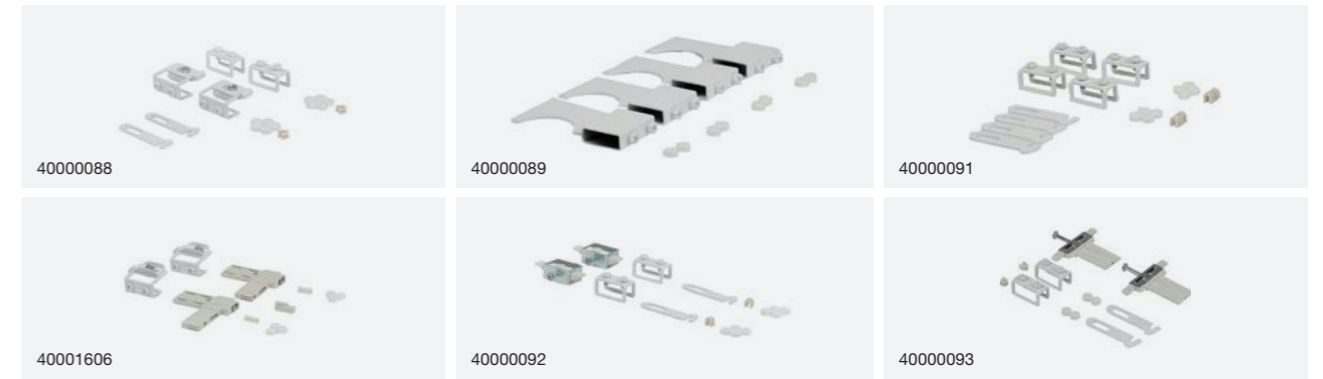

DUO STANDPIPE SET

Article no.	Description	
40000088	Duo mounting set standard (Type 11, 20 & 21)	12 SE/2
40000089	Duo mounting set column radiator	12 SE/2
40000091	Duo mounting set lug fixing (also for compact radiator type 11)	12 SE/2
40000092	Duo mounting set inner mounting 1	12 SE/2
40000093	Duo mounting set inner mounting 2 (Type 22 & 33)	12 SE/2
40001606	Duo mounting set inner mounting 3 (Type 21)	12 SE/2

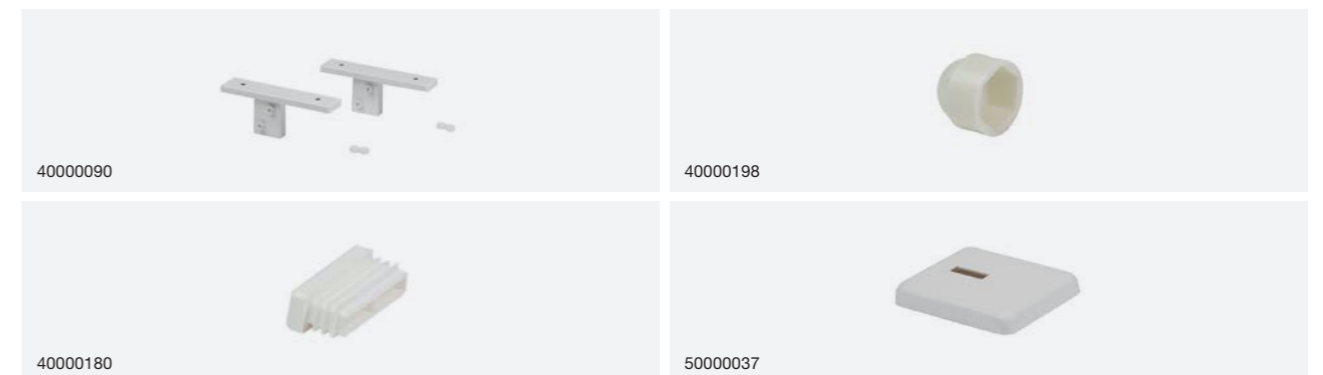

ACCESSORIES FLOOR BRACKETS

Article no.	Description	
40000090	Duo window-still support 160mm	12 SE/2
40000180	Cover floor bracket	100 pc
40000198	Bolt cap M8	100 pc
50000037	Bottom cover for Rofix floor bracket	24 pc

SAFE
SECURE
SOLID

ROFIX

T +32 (0)89 79 03 30

E info@rofix.com

WWW.ROFIX.COM